



blackoveja.com

A1

ROUNDED TOTE - LARGE

ROUNDED TOTE

A2

B1

POSICIÓN ASA (3cm)

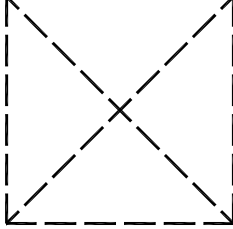

OTE - MEDIUM

POSICIÓN ASA (3cm)

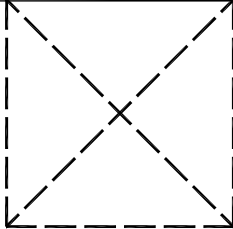

EJE DE SIMETRIA - DOBLAR TELA POR AQUI





blackoveja.com

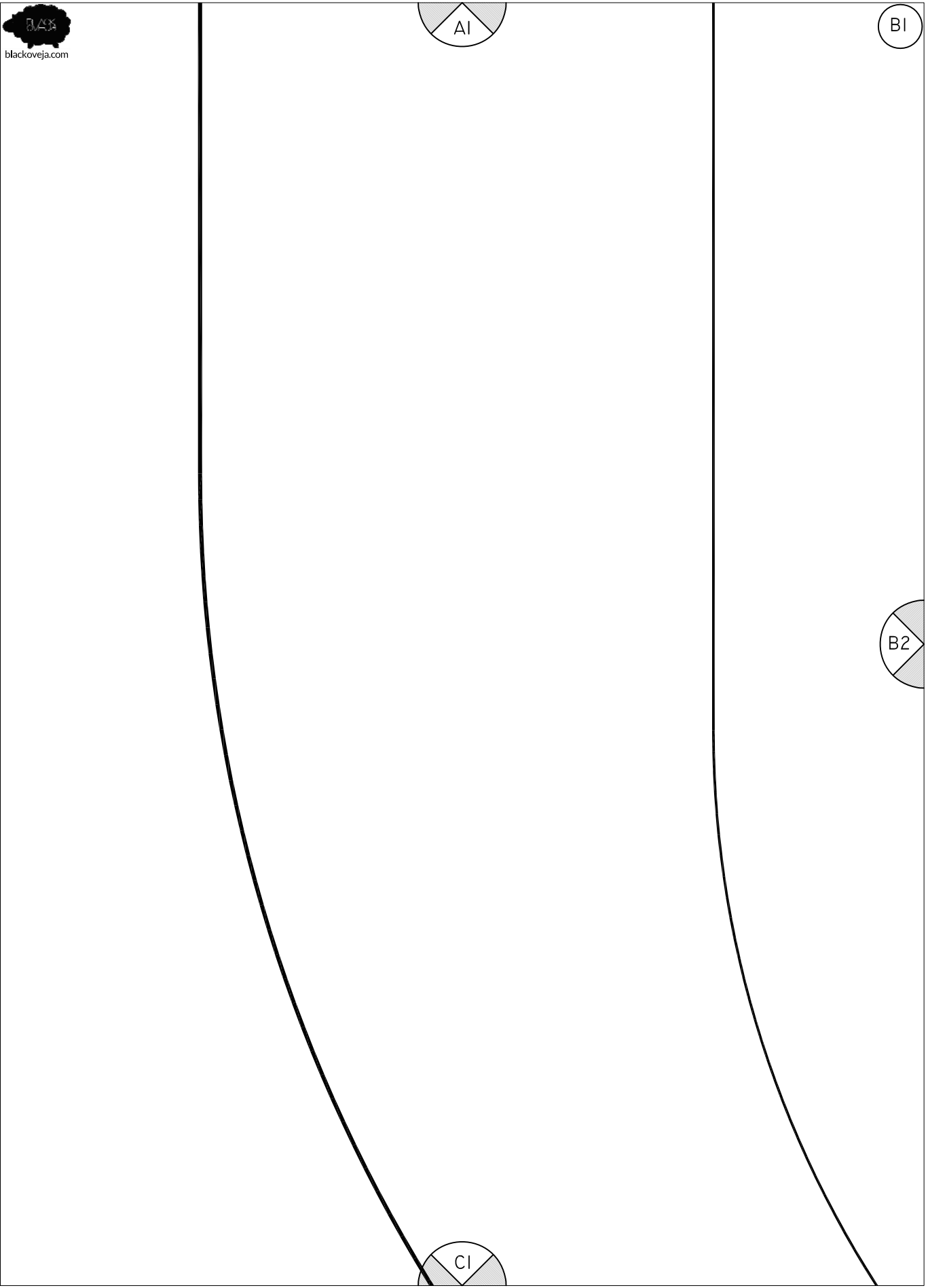
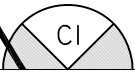
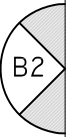
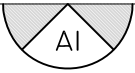



www.blackoveja.com

# Ultrafácil & resultón

## ROUNDED TOTE

### Patrón descargable gratuito (\*)

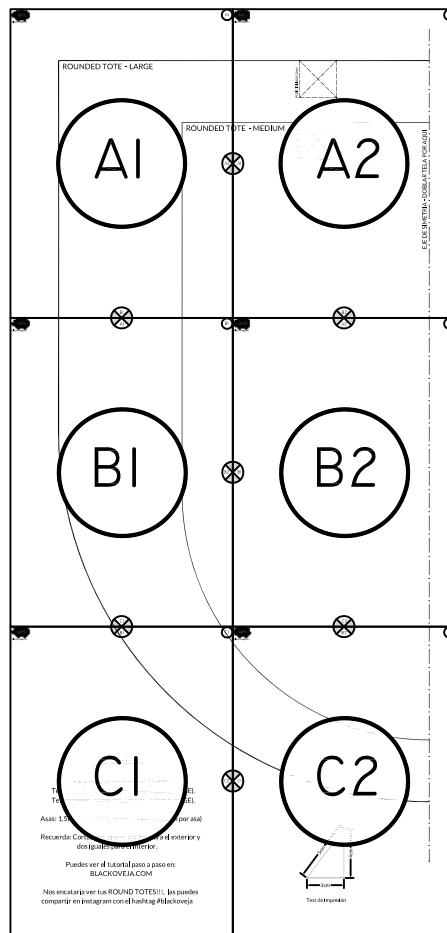

Imprime este PDF en A4 vertical sin escala.

Comprueba las dimensiones con el gráfico de la página C2

(\*) Patrón para uso exclusivamente doméstico.



## Necesitas:

Para telas ancho mínimo 110cm:

Tela exterior: 50cm (MEDIUM) - 60cm (LARGE).

Tela interior: 50cm (MEDIUM) - 60cm (LARGE).

Asas: 1,5m cinta de algodón de 3 - 4 cm (75cm por asa)

Recuerda: Cortad dos piezas iguales para el exterior y dos iguales para el interior.

Puedes ver el tutorial paso a paso en:

[BLACKOVEJA.COM](http://BLACKOVEJA.COM)

Nos encantaria ver tus ROUND TOTES!!!, las puedes compartir en instagram con el hashtag #blackoveja



blackoveja.com

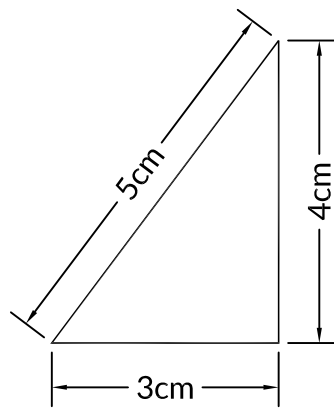
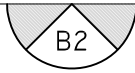

Test de impresión