



www.blackoveja.com

Ultrafácil & resultón DELANTAL JAPO

Patrón descargable gratuito (*)

Doblar tela - talla L

Doblar tela - talla M

Doblar tela - talla S

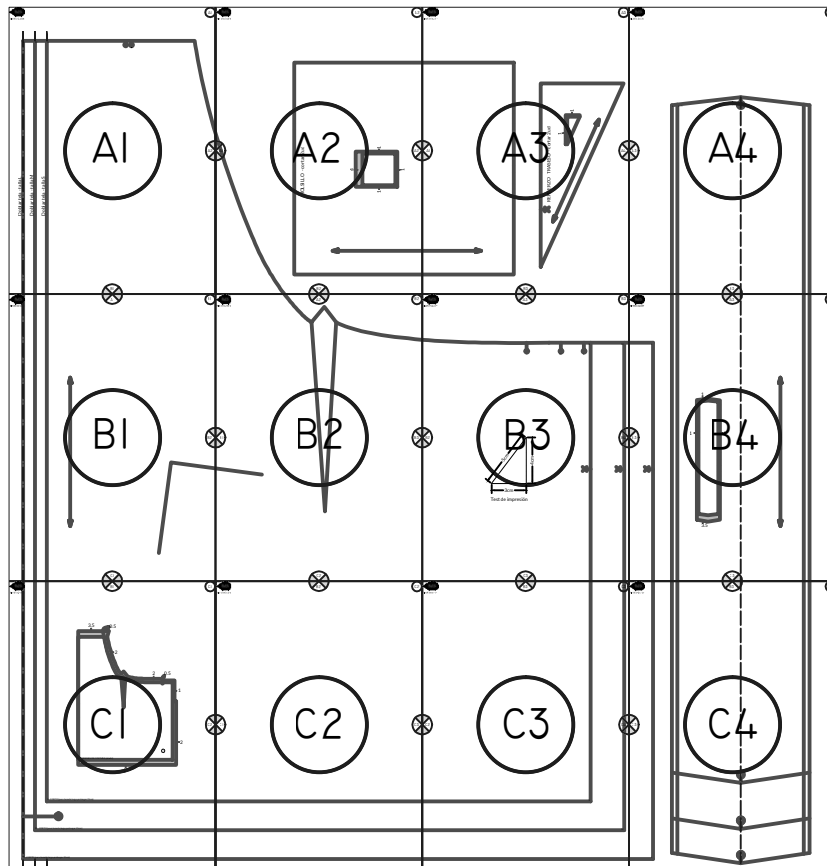

Imprime este PDF en A4 vertical sin escala.

Comprueba las dimensiones con el gráfico de la página C2

(*) Patrón para uso exclusivamente doméstico.

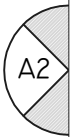

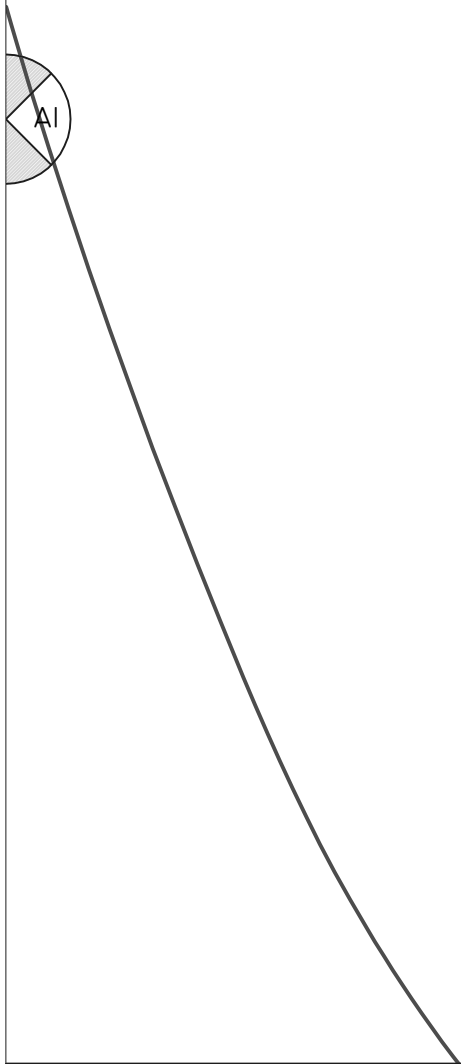

BOLSILLO - cortar 2ud

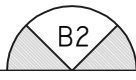
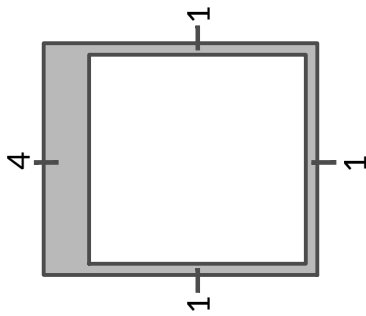

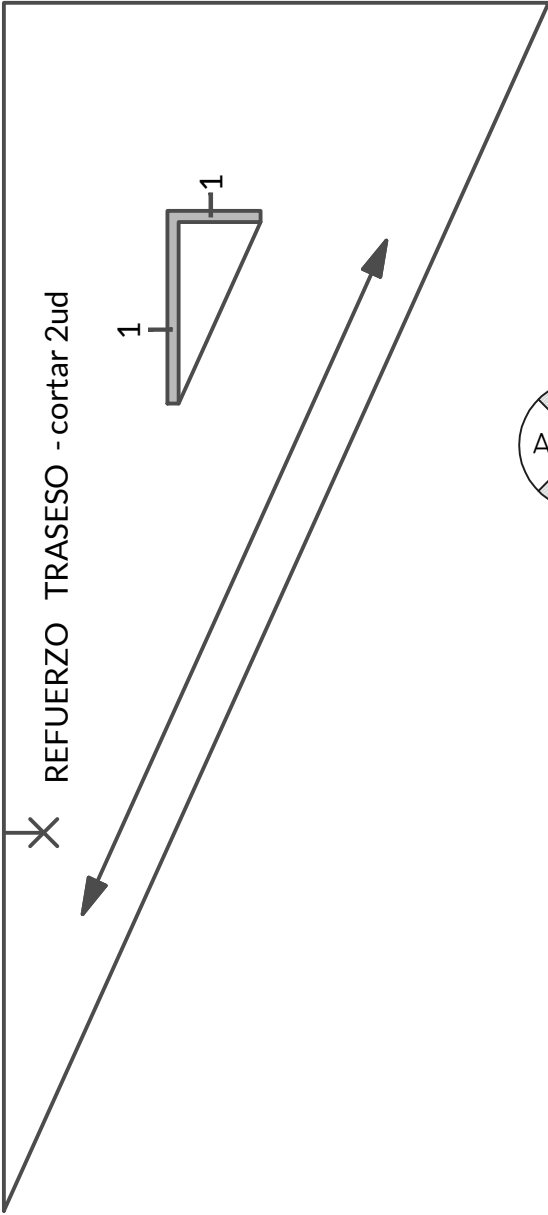
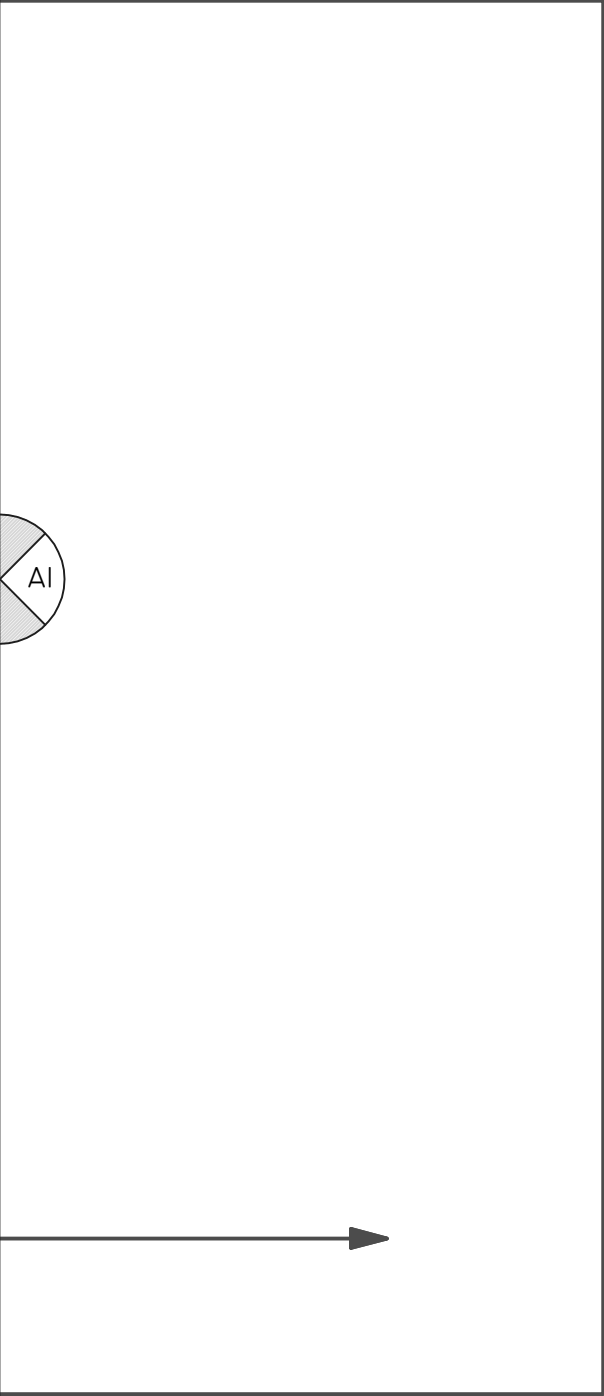

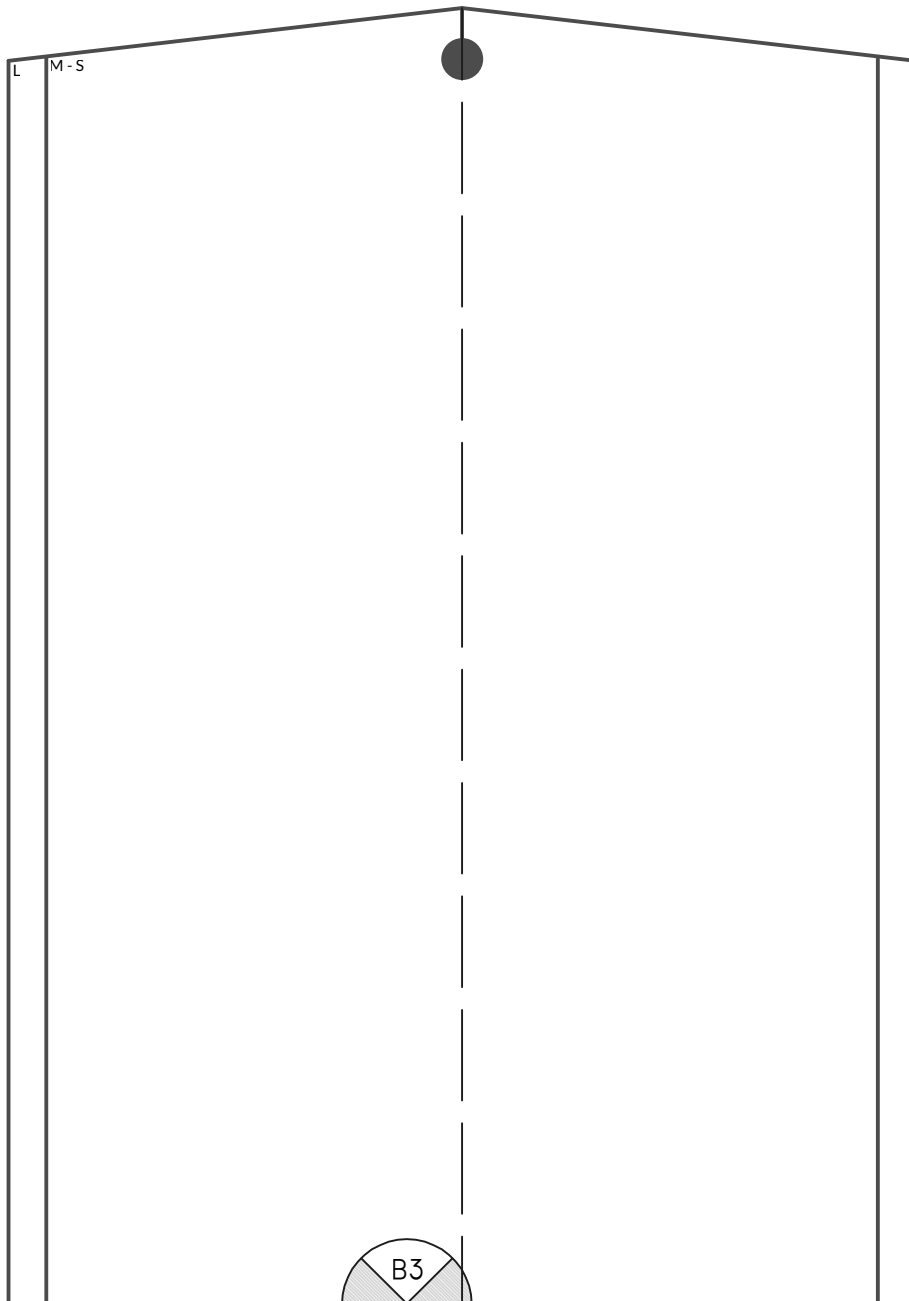

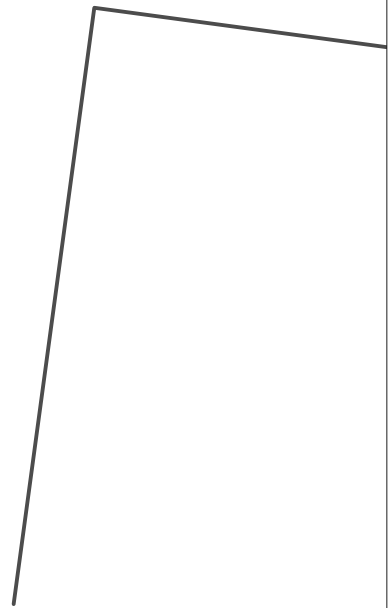
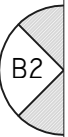

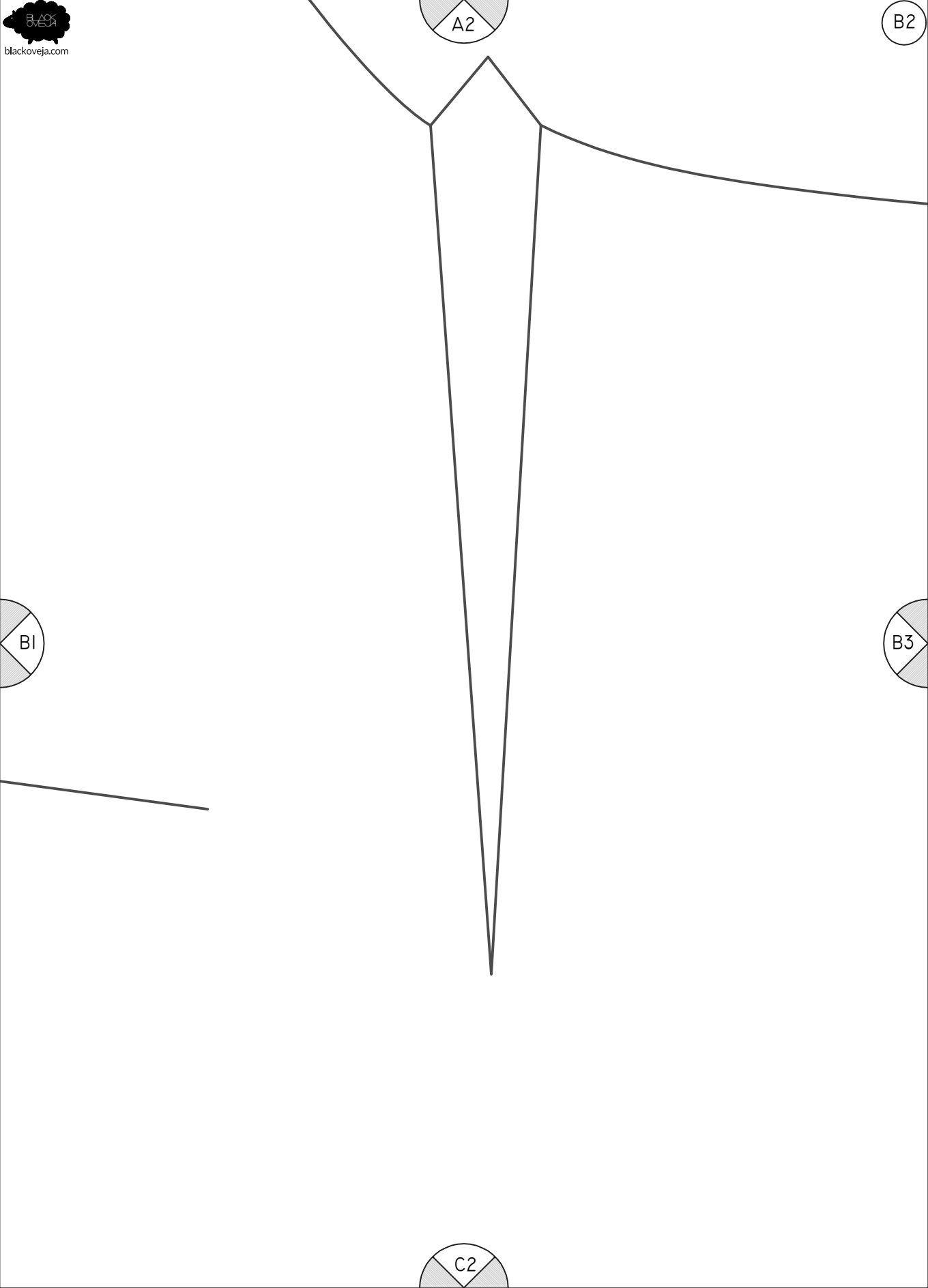

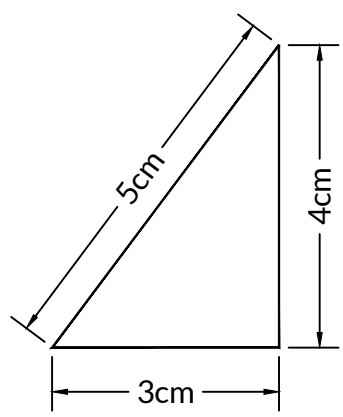
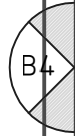

Test de impresión



L

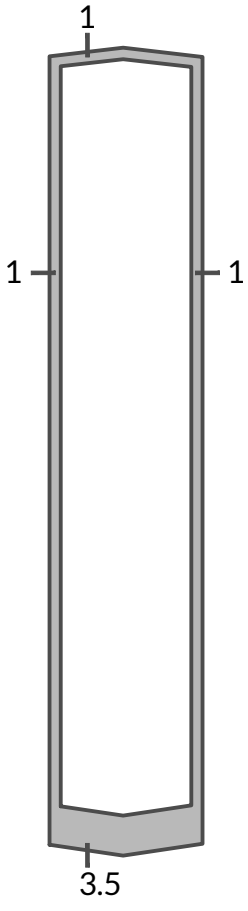

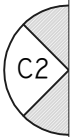
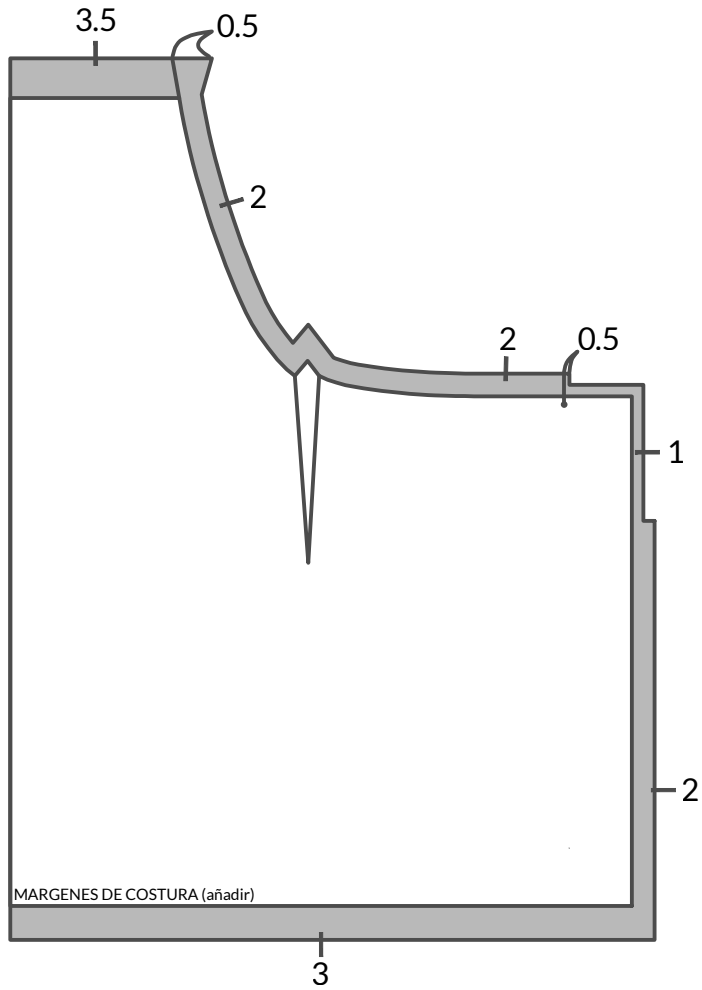
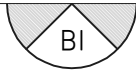

S - CORTO (para tamaño largo prolongar 25cm)

M - CORTO (para tamaño largo prolongar 25cm)

L - CORTO (para tamaño largo prolongar 25cm)

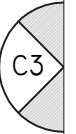

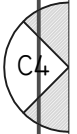
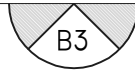

S

M

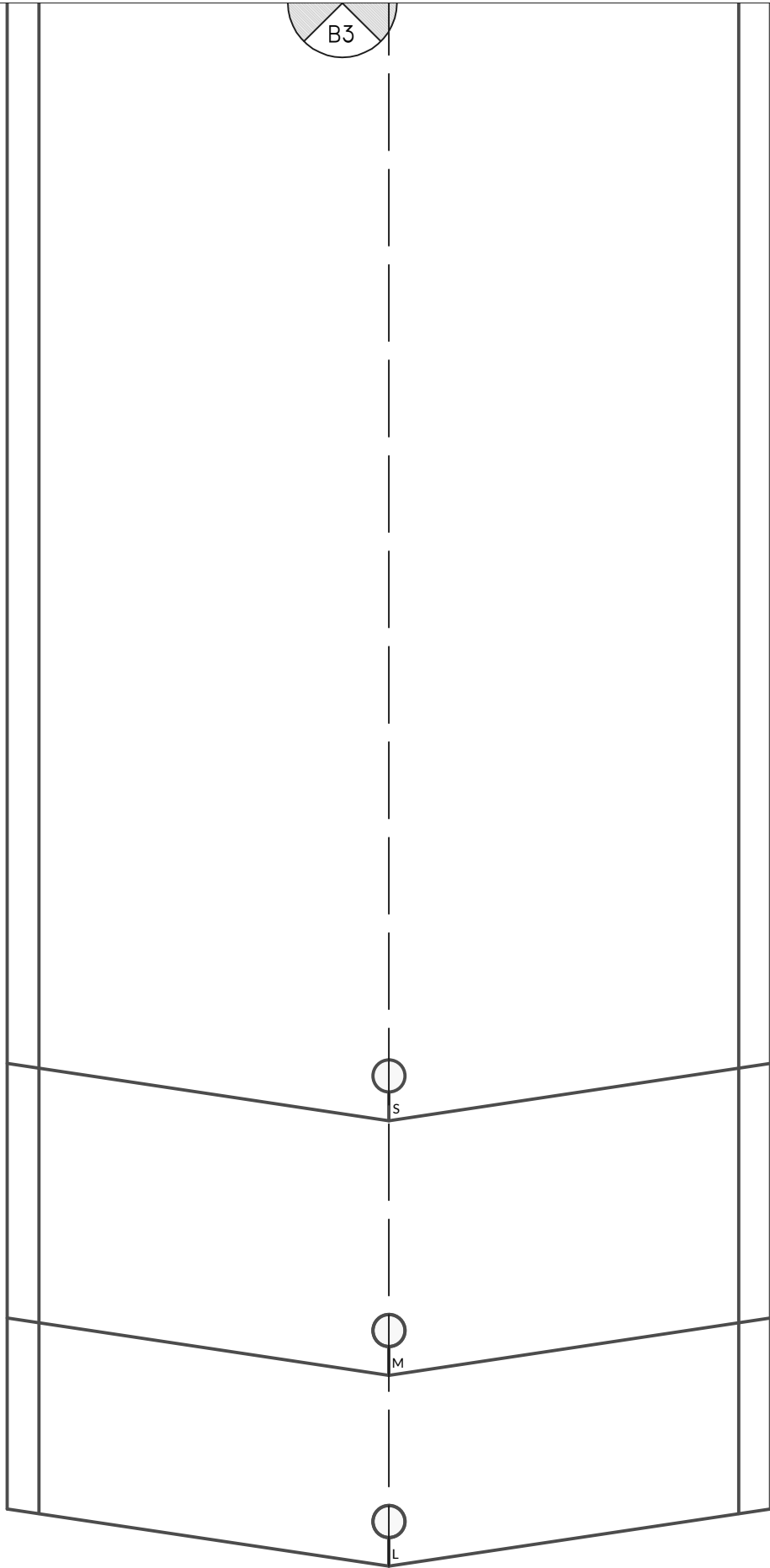
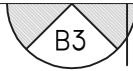

L